

20V N-Channel Enhancement Mode MOSFET

Description

The UP8810TE uses advanced trench technology to provide excellent $R_{DS(ON)}$, low gate charge and operation with gate voltages as low as 2.5V. This device is suitable for use as a load switch or in PWM applications. It is ESD protected.

General Features

- $V_{DS} = 20V, I_D = 6A$
- $R_{DS(ON)} < 30m\Omega @ V_{GS}=2.5V$
- $R_{DS(ON)} < 28m\Omega @ V_{GS}=4.5V$
- ESD Rating: 2000V HBM
- High Power and current handling capability
- Lead free product is acquired
- Surface mount package

Application

- PWM application
- Load switch

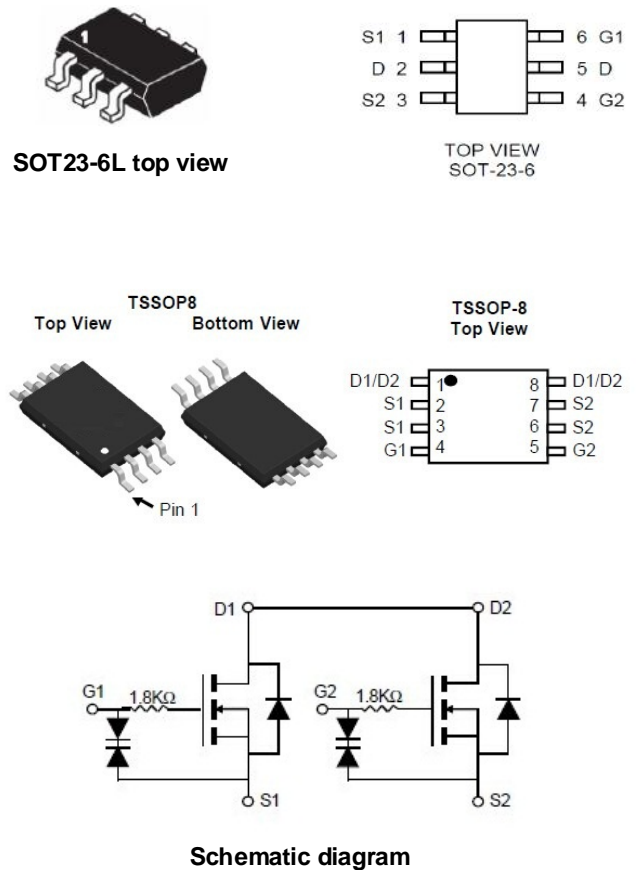

Package Marking and Ordering Information

Device Marking	Device	Device Package	Reel Size	Tape width	Quantity
8810	8810	SOT23 - 6L/TSSOP-8	Ø330mm	12mm	3000 units

Absolute Maximum Ratings ($T_A=25^\circ C$ unless otherwise noted)

Parameter	Symbol	Limit	Unit
Drain-Source Voltage	V_{DS}	20	V
Gate-Source Voltage	V_{GS}	± 12	V
Drain Current-Continuous	I_D	6	A
Drain Current-Pulsed ^(Note 1)	I_{DM}	30	A
Maximum Power Dissipation	P_D	1.25	W
Operating Junction and Storage Temperature Range	T_J, T_{STG}	-55 To 150	$^\circ C$

Thermal Characteristic

Thermal Resistance, Junction-to-Ambient ^(Note 2)	$R_{\theta JA}$	100	$^\circ C/W$
---	-----------------	-----	--------------

Electrical Characteristics (TA=25°C unless otherwise noted)

Parameter	Symbol	Condition	Min	Typ	Max	Unit
Off Characteristics						
Drain-Source Breakdown Voltage	BV _{DSS}	V _{GS} =0V, I _D =250μA	20		-	V
Zero Gate Voltage Drain Current	I _{DSS}	V _{DS} =20V, V _{GS} =0V	-	-	1	μA
Gate-Body Leakage Current	I _{GSS}	V _{GS} =±10V, V _{DS} =0V	-	-	±10	μA
On Characteristics (Note 3)						
Gate Threshold Voltage	V _{GS(th)}	V _{DS} =V _{GS} , I _D =250μA	0.45	0.7	1.0	V
Drain-Source On-State Resistance	R _{DS(ON)}	V _{GS} =4.5V, I _D =6A	-	21	28	mΩ
		V _{GS} =2.5V, I _D =5A	-	25	30	mΩ
Forward Transconductance	g _{FS}	V _{DS} =5V, I _D =6A	-	20	-	S
Dynamic Characteristics (Note 4)						
Input Capacitance	C _{iss}	V _{DS} =10V, V _{GS} =0V, F=1.0MHz	-	650	-	PF
Output Capacitance	C _{oss}		-	140	-	PF
Reverse Transfer Capacitance	C _{rss}		-	60	-	PF
Switching Characteristics (Note 4)						
Turn-on Delay Time	t _{d(on)}	V _{DD} =10V, R _L =1.5Ω V _{GS} =5V, R _{GEN} =3Ω	-	0.5		nS
Turn-on Rise Time	t _r		-	1		nS
Turn-Off Delay Time	t _{d(off)}		-	12		nS
Turn-Off Fall Time	t _f		-	4		nS
Total Gate Charge	Q _g	V _{DS} =10V, I _D =6A, V _{GS} =4.5V	-	8		nC
Gate-Source Charge	Q _{gs}		-	2.5	-	nC
Gate-Drain Charge	Q _{gd}		-	3	-	nC
Drain-Source Diode Characteristics						
Diode Forward Voltage	V _{SD}	V _{GS} =0V, I _S =1A	-	-	1.2	V
Diode Forward Current	I _S		-	-	6	A

Notes:

1. Repetitive Rating: Pulse width limited by maximum junction temperature.
2. Surface Mounted on FR4 Board, t ≤ 10 sec.
3. Pulse Test: Pulse Width ≤ 300μs, Duty Cycle ≤ 2%.
4. Guaranteed by design, not subject to production



Typical Electrical and Thermal Characteristics

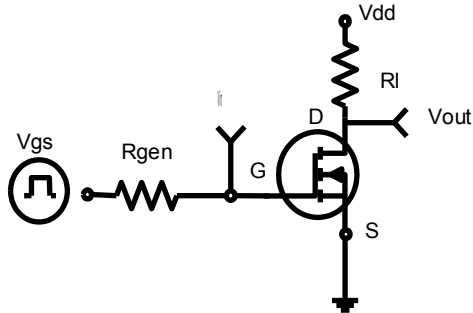

Figure 1: Switching Test Circuit

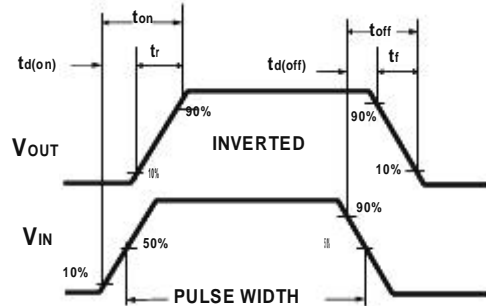

Figure 2: Switching Waveforms

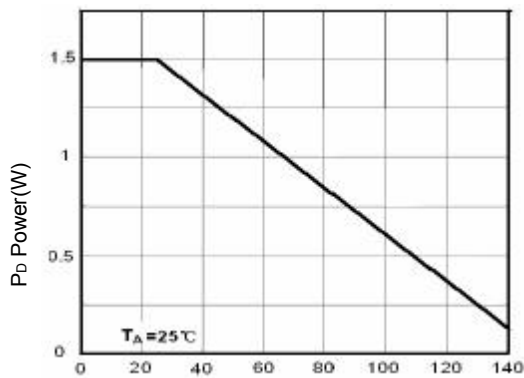

Figure 3 Power Dissipation

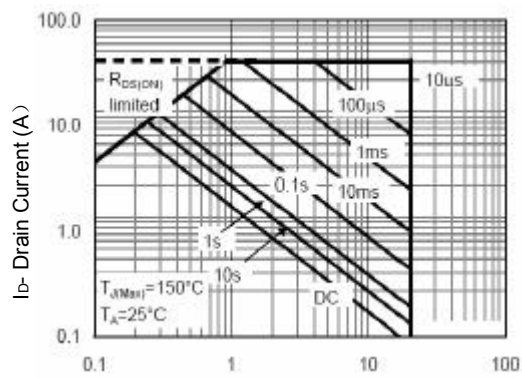

Figure 4 Safe Operation Area

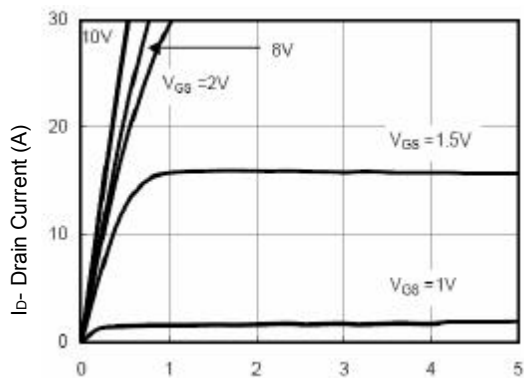

Figure 5 Output Characteristics

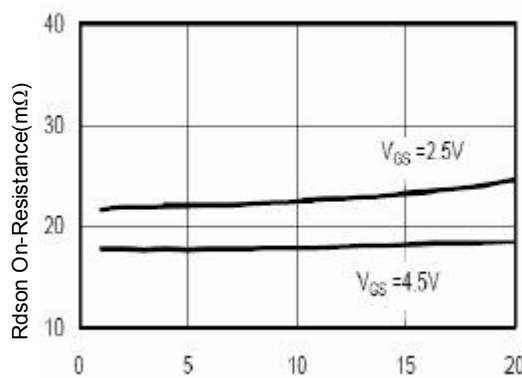
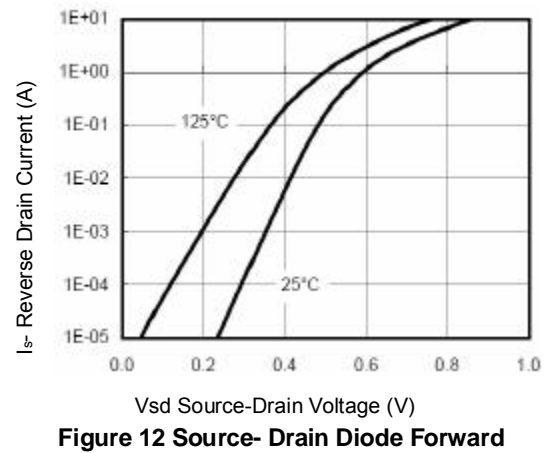
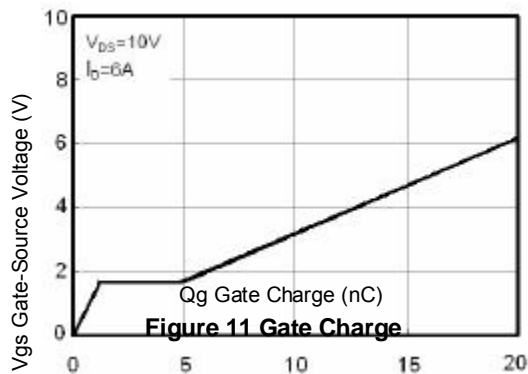
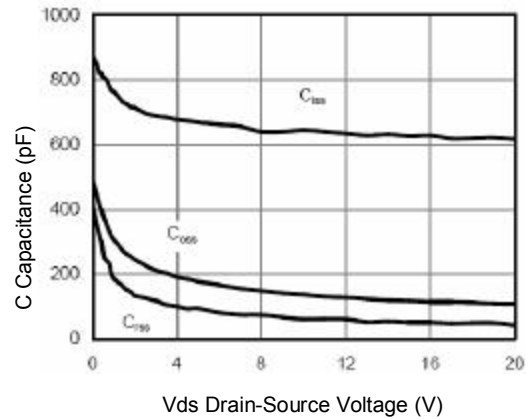
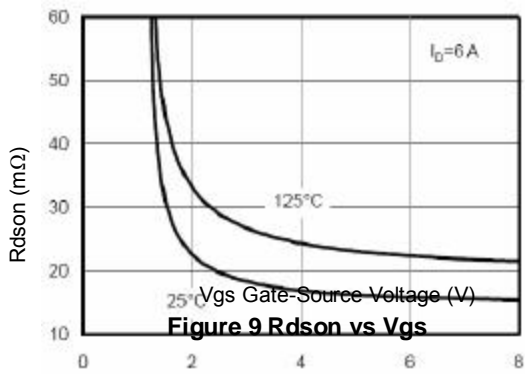
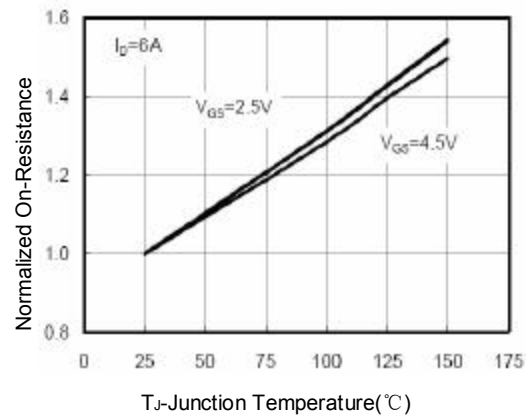
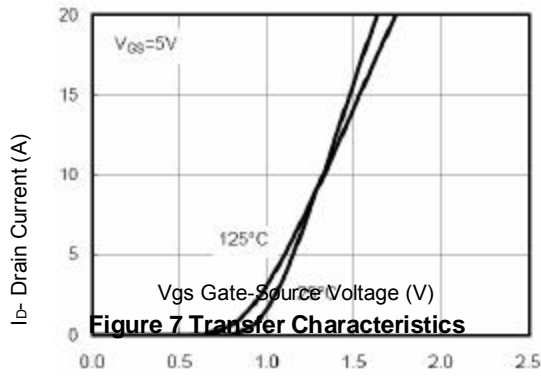

Figure 6 Drain-Source On-Resistance



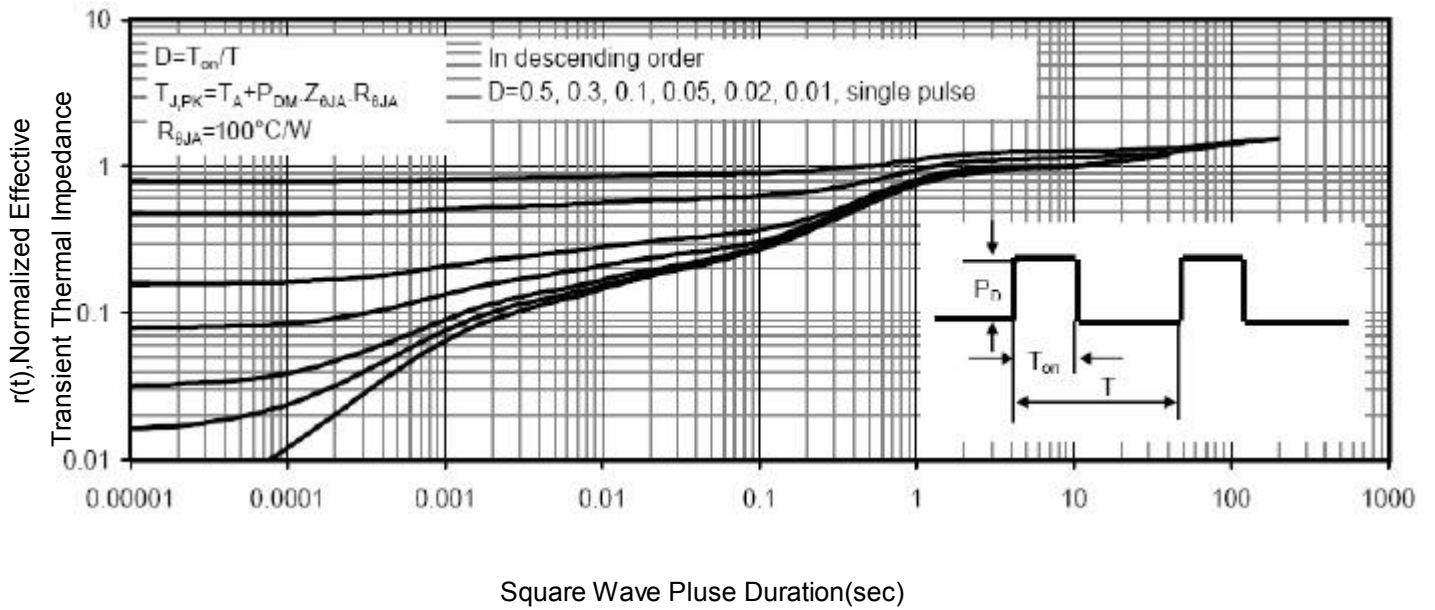
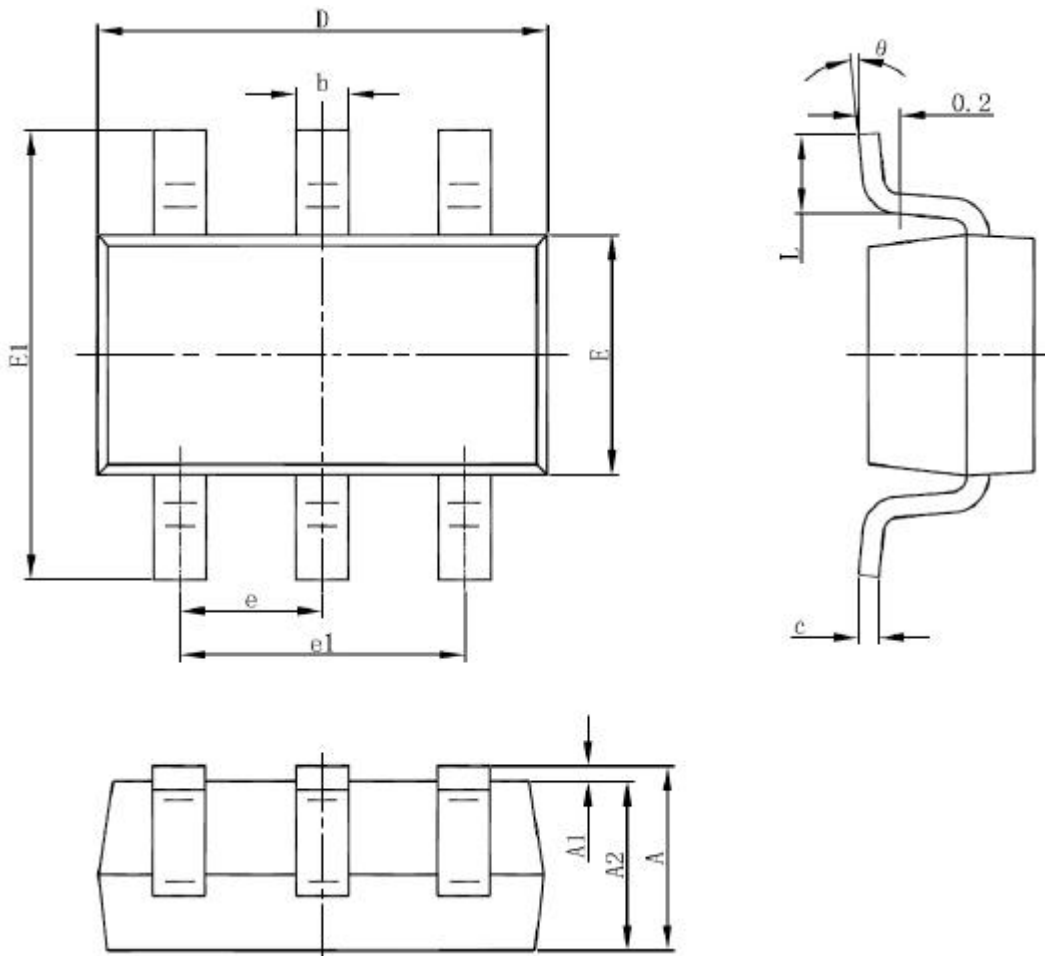

Figure 13 Normalized Maximum Transient Thermal Impedance



SOT23-6L Package Information



Symbol	Dimensions In Millimeters		Dimensions In Inches	
	Min	Max	Min	Max
A	1.050	1.250	0.041	0.049
A1	0.000	0.100	0.000	0.004
A2	1.050	1.150	0.041	0.045
b	0.300	0.500	0.012	0.020
c	0.100	0.200	0.004	0.008
D	2.820	3.020	0.111	0.119
E	1.500	1.700	0.059	0.067
E1	2.650	2.950	0.104	0.116
e	0.950(BSC)		0.037(BSC)	
e1	1.800	2.000	0.071	0.079
L	0.300	0.600	0.012	0.024
θ	0°	8°	0°	8°